

# M. Denis "IBIS Mass Model Web Service"

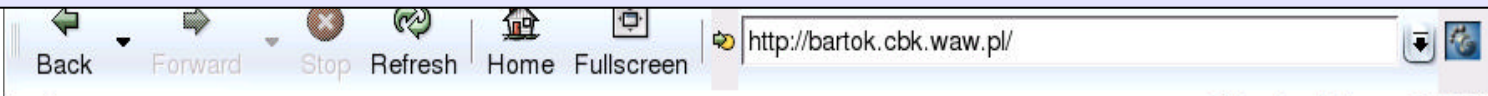

<http://bartok.cbk.waw.pl>

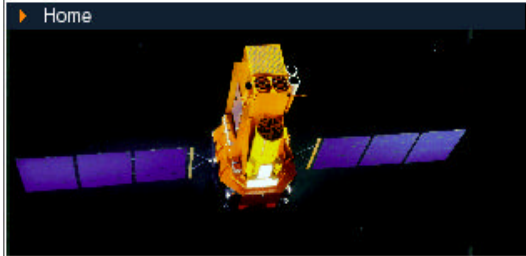

search...

**Main Menu**

- Home
- News
- Phgen Doc
- Geo

Welcome to the IBIS Mass Model  
**MM 5.2 - IBIS with INTEGRAL**  
Written by MD  
Friday, 26 November 2004

Access to the most of the resources  
is protected!  
To get the access send an e-mail to:  
**[miro@cbk.waw.pl](mailto:miro@cbk.waw.pl)**

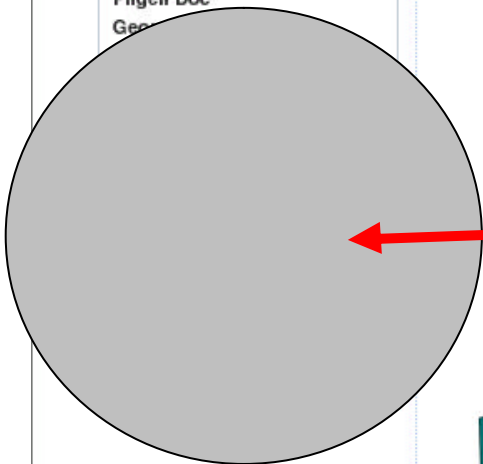
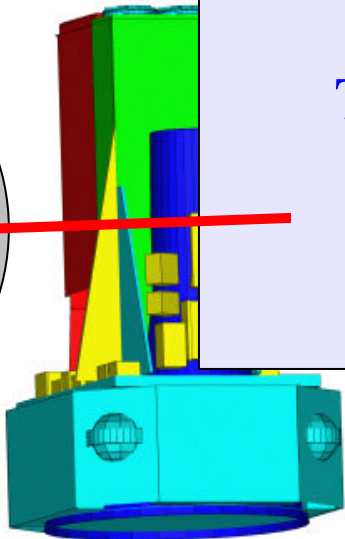

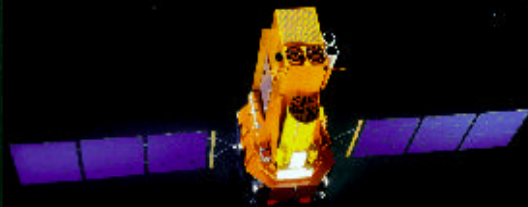

# IBIS Mass Model

Space Research Center, Polish Academy of Sciences  
E-mail: miro@cbk.waw.pl

Welcome to  
**MM 5.2 - I**  
Written by  
Friday, 26

## Main Menu

- Home
- News
- Status
- Run
- Results
- Phgen Doc
- Geom Doc
- Polarimetry

## User Menu

- Your Details
- Submit News
- Check-In My Items

## Login Form

Hi, miro  
Logout

## Online Users

miro

## Web Interface to the IBIS Mass Model:

- ? News on MM, IBIS simulator
- ? IBIS MM Status (Jobs, CPUs, ..)
- ? Parameter form for IBIS MM run
- ? Results browsing and downloading
- ? Documentation

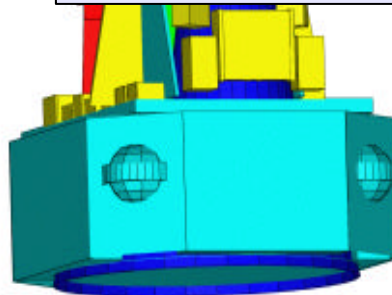

# IBIS MM Engine – Geant 3 + polarization

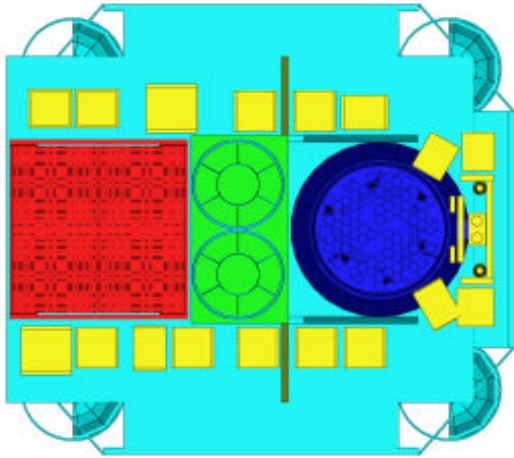

- ? Detailed IBIS MM 5.2 (2004)
- ? TIMM 3.0 (1998)
- ? Photon generator
- ? “Electronic” post-processing
- ? Output: event lists, spectra (ASCII fmt)

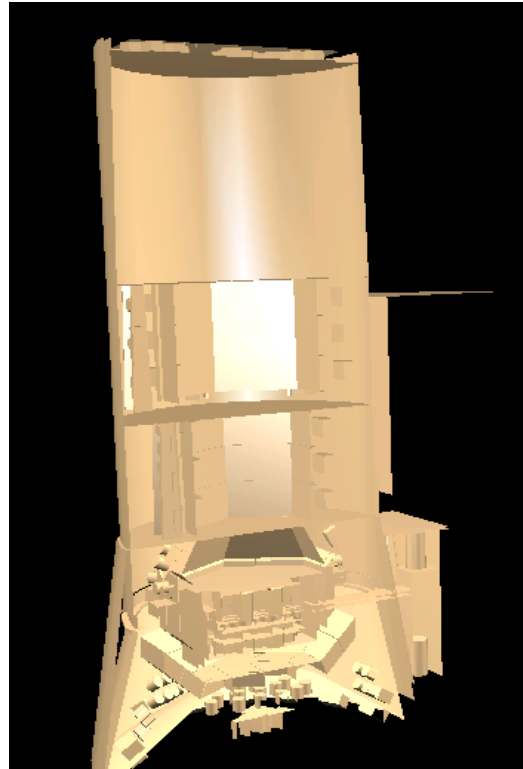
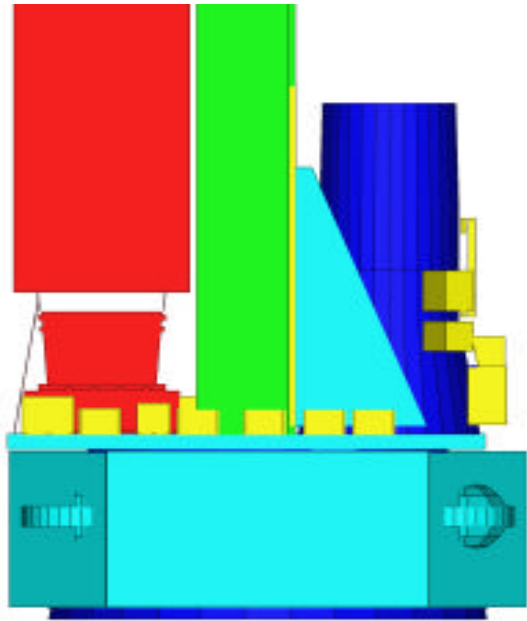

# IBIS Mass Model Front End - Run

## Parameter form for ISIM

Job's name

Run name: miro- bkg\_pl\_line\_01

IBIS model: EN, FL, FM, IM

IBIS Model: FM Test particle: Photon

Time (seconds): start 0 stop 1000

Duration of the observation

Source Id Source Type

Parameters

0 BKG\_SRC

Flux (photons/s): 3000

Instrumental background

1 PLAW\_SRC

Flux (photons/s): 1000

Power law

Polar angle (deg): 5

Azimuthal angle (deg): 0

Energy start (keV): 30

Energy end (keV): 3000

Spectral index: -2

Polarization angle (deg): -1

Different sources, spectral components

2 MONO\_SRC

Flux (photons/s): 100

Monochromatic emission li

Polar angle (deg): 5

Azimuthal angle (deg): 0

Energy (keV): 300

Polarization angle (deg): -1

3 NO\_SRC

4 NO\_SRC

5 NO\_SRC

# IBIS Mass Model Front End - Submitted

## Parameter form for ISIM

USER miro

Your parameter form has been submitted with the working id:

*miro-bkg\_pl\_line\_01*

See 'Status' and 'Results' for further info.

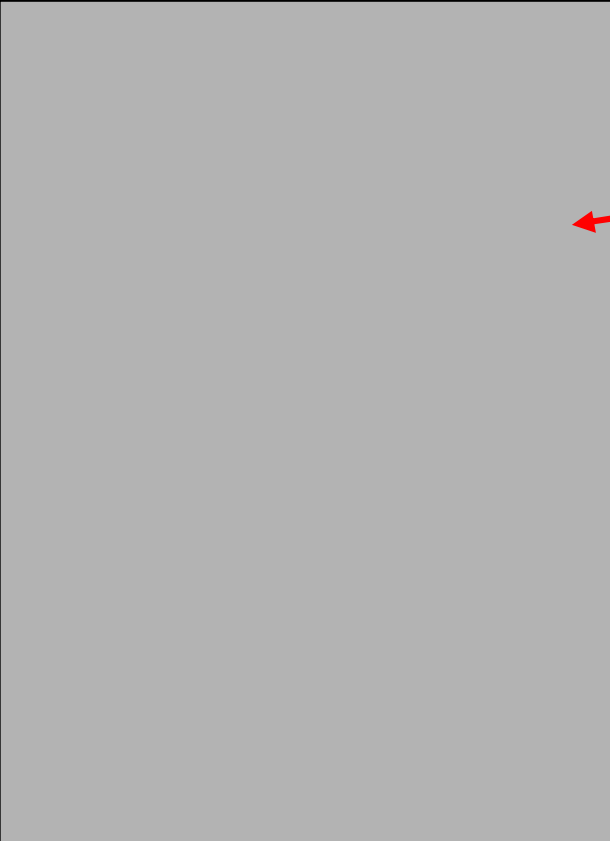

Standard geant3 parameter file,  
with some IBIS MM specific additional  
parameters: SMDL SPAR SPRT SS<sub>xx</sub>

# IBIS Mass Model Front End – Status 1

Cluster configuration



Max number of simultaneous jobs: 20

## ISIM running:

Job	server	proc	PID	Par file	Exec.time	s	R
1	c9.giganet-0	30665	miro-grb030329-1191.99.par	1832	0.51	A	

Job's queue



## Recent log:

Sun Jan 16 09:54:01 CET 2005: cluster conf: 0 1 2 load: 9:54am up 16 days 22:14, 1 user, load average: 0.00, 0.00, 0.00

Sun Jan 16 09:48:08 CET 2005: c7 conf: 0 1 2 load: 9:48am up 16 days 19:21, 0 users, load average: 0.00, 0.00, 0.00

Sun Jan 16 09:50:11 CET 2005: c8 conf: 0 1 2 load: 9:50am up 42 days 18:04, 3 users, load average: 0.00, 0.00, 0.00

# IBIS Mass Model Front End – Status 2

## Status of ISIM

### ISIM configuration:

1	bolero	Sun Jan 16 10:00:04 CET 2005	0,20,40	****	0	1
2	c1	Sun Jan 16 10:00:07 CET 2005	2,22,42	****	0	1 2
3	c4	Sun Jan 16 10:00:08 CET 2005	4,24,44	****	0	1 2
4	c6.giganet	Sun Jan 16 09:53:40 CET 2005	6,26,46	****	0	1
5	c7	Sun Jan 16 10:00:26 CET 2005	8,28,48	****	0	1 2
6	c8	Sun Jan 16 10:00:26 CET 2005	10,30,50	****	0	1 2
7	c9.giganet	Sun Jan 16 10:00:27 CET 2005	12,32,52	****	0	
8	cluster	Sun Jan 16 10:08:19 CET 2005				

Job is running, on-line progress status

Max number of simultaneous jobs: 20

### ISIM running:

2	c9.giganet-0	30665	miro-grb030329-1191.99.par	1832	0.51	44.21	16.20	4.50%
---	--------------	-------	----------------------------	------	------	-------	-------	-------

### ISIM queue:

1

# IBIS Mass Model Front End – Results

Content of miro-bkg.pl line 01:

Delete

miro-

Statistics

Parameters

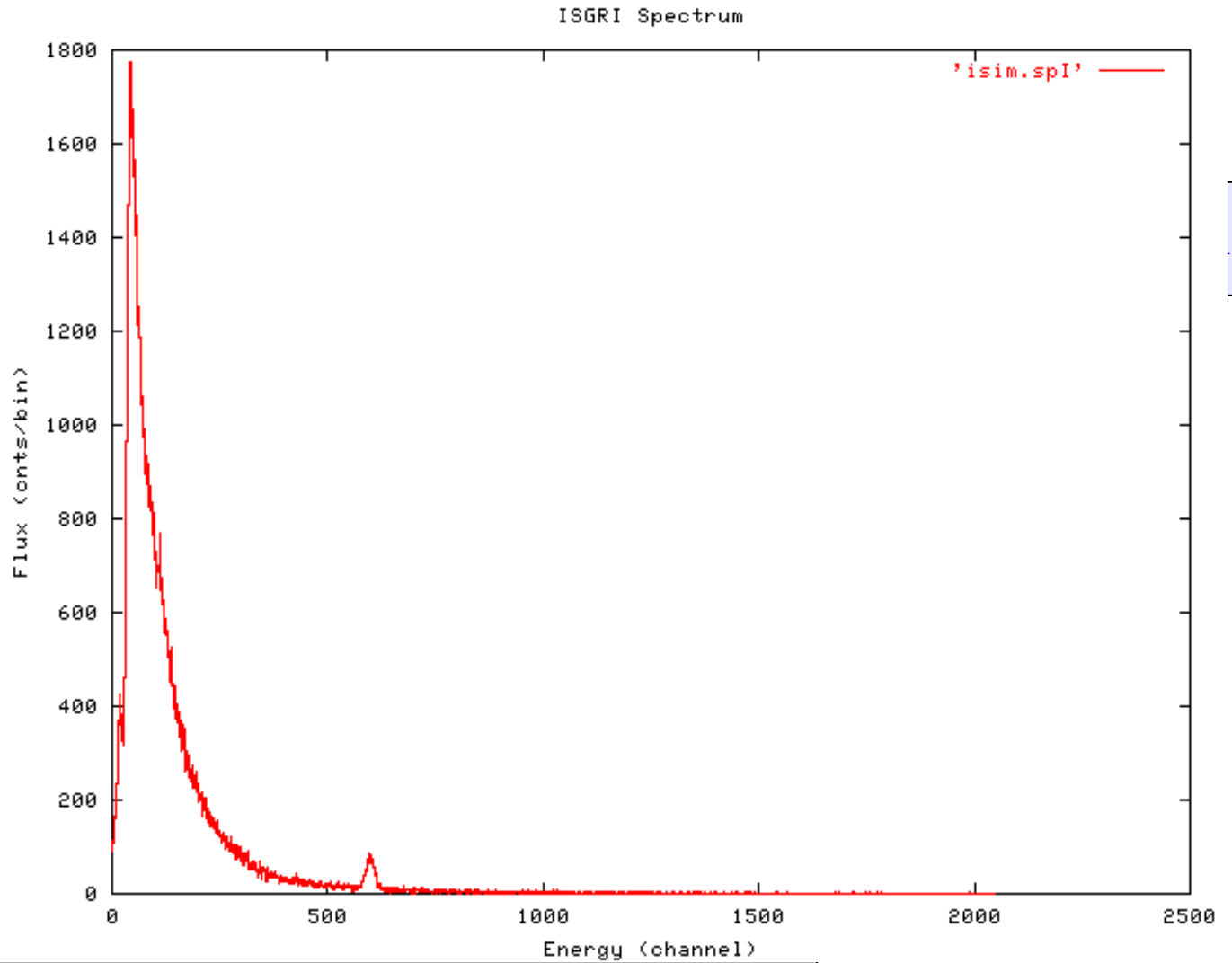

ct



**Web front end to the IBIS Mass Model is available:**

- ? Geant3 engine, detailed IBIS geometry, simplified INTEGRAL
- ? Polarization module extra added
- ? Several spectral models available
- ? Field of view and arbitrary direction sources

**To do:**

- ? Producing the response matrices in an “automatic way”